

Made for  
iPhone | iPad | iPod

Works with  
android

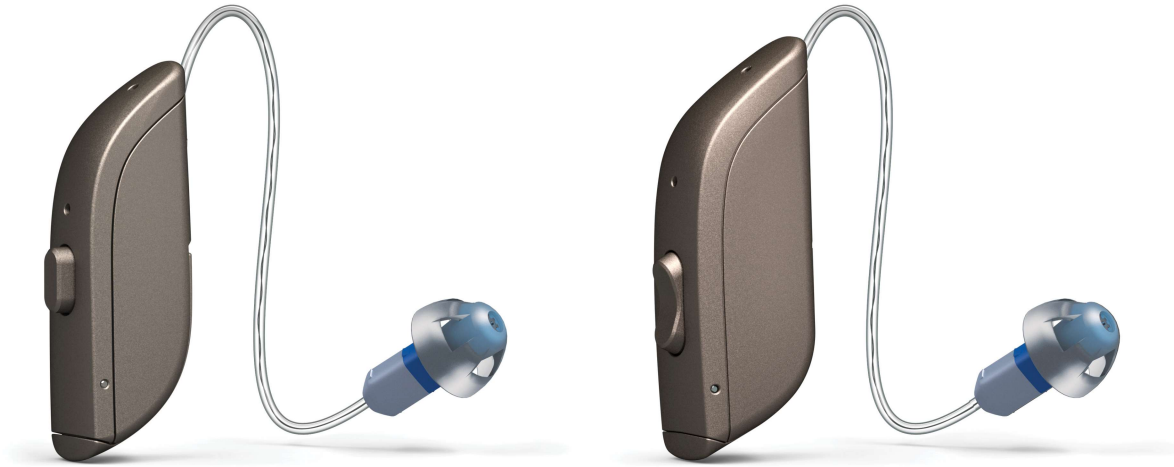

ReSound OMNIA

# User guide

ReSound Receiver-In-Ear hearing aids

GN Making Life Sound Better

resound.com

# Hearing aid information

Left hearing aid		Right hearing aid	
Serial number		Serial number	
Model number		Model number	
Battery type	<input type="checkbox"/> Zinc-Air 312 <input type="checkbox"/> Zinc-Air 13		

Dome/ earmold type	Closed dome	Open dome	Power dome	<input type="checkbox"/> Tulip dome	<input type="checkbox"/> RIE earmold
	<input type="checkbox"/> Small <input type="checkbox"/> Medium <input type="checkbox"/> Large	<input type="checkbox"/> Small <input type="checkbox"/> Medium <input type="checkbox"/> Large	<input type="checkbox"/> Small <input type="checkbox"/> Medium <input type="checkbox"/> Large		

Program	Beep	Description
1	One beep	
2	Two beeps	
3	Three beeps	
4	Four beeps	

# FDA warnings and cautions (US only)

**WARNING: People younger than 18 should go to a doctor before using this**

People younger than 18 years old need specialized care, and using this without a medical evaluation may worsen impairment or disability. A hearing aid user who is younger than 18 should have a recent medical evaluation from a doctor, preferably an ear-nose-throat doctor (an ENT). Before using this, a doctor should determine that the use of a hearing aid is appropriate.



**WARNINGS to Hearing Aid Dispensers**

You should advise a prospective hearing aid user to consult promptly with a doctor, preferably an ear specialist such as an ENT, before dispensing a hearing aid if you determine through inquiry, actual observation, or review of any other available information concerning the prospective user, that the prospective user has any of the following conditions:

- Visible deformity of the ear, either congenital or traumatic
- Fluid, pus, or blood coming out of the ear within the previous 6 months
- Pain or discomfort in the ear
- History of excessive ear wax or suspicion that something is in the ear canal
- Dizziness, either recent or long-standing
- Sudden, quickly worsening, or fluctuating hearing loss within the previous 6 months

- Hearing loss or ringing (tinnitus) only in one ear or noticeable difference in hearing between ears
- Audiometric air-bone gap equal to or greater than 15 dB at 500 Hz, 1000 Hz, and 2000 Hz.

**Outputs over 132 dB SPL:**

You should exercise special care in selecting and fitting a hearing aid with a maximum output that exceeds 132 dB SPL because it may impair the remaining hearing of the hearing aid user.

**Sound pressure level in the ears of children:**

The developed sound pressure level in the ears of children can be substantially higher than in average adults. It is recommended to perform an RECD measurement in order to ensure the correct target for the fitted OSPL90.



**CAUTION:**

**This is not hearing protection**

You should remove this device if you experience overly loud sounds, whether short or long-lasting. If you're in a loud place, you should use the right kind of hearing protection instead of wearing this device. In general, if you would use ear plugs in a loud place, you should remove this device and use ear plugs.

**The sound output should not be uncomfortable or painful**

You should turn down the volume or remove the device if the sound output is uncomfortably loud or painful. If you consistently need to turn the volume down, you may need to further adjust your device.

### **You might need medical help if a piece gets stuck in your ear**

If any part of your hearing aid, like the eartip (dome), gets stuck in your ear, and you can't easily remove it with your fingers, get medical help as soon as you can. You should not try to use tweezers or cotton swabs because they can push the part further into your ear, injuring your eardrum or ear canal, possibly seriously.



#### **NOTE:**

### **What you might expect when you start using your hearing aid**

- A hearing aid can benefit many people with hearing loss. However, you should know it will not restore normal hearing, and you may still have some difficulty hearing over noise. Further, a hearing aid will not prevent or improve a medical condition that causes hearing loss.
- People who start using hearing aids sometimes need a few weeks to get used to them. Similarly, many people find that training or counseling can help them get more out of their devices.
- If you have hearing loss in both ears, you might get more out of using hearing aids in both, especially in situations that make you tired from listening – for example, noisy environments.

### **Tell FDA about injuries, malfunctions, or other adverse events**

- To report a problem involving your hearing aid, you should submit information to FDA as soon as possible after the problem. FDA calls them “adverse events”, and they might include: skin irritation in your ear, injury from the device (like cuts or scratches, or burns from an overheated battery), pieces of the device getting stuck in your ear, suddenly worsening hearing loss from using the device, etc. Instructions for reporting are available at <https://www.fda.gov/Safety/MedWatch>, or call 1-800-FDA-1088. You can also download a form to mail to FDA.

### **Hearing loss in people younger than 18**

- People younger than 18 should see a doctor first, preferably an ear-nose-throat doctor (an ENT), because they may have different needs than adults.
- The doctor will identify and treat medical conditions as appropriate.
- The doctor may refer the person to an audiologist for a separate test, a hearing aid evaluation.
- The hearing aid evaluation will help the audiologist select and fit the appropriate hearing aid.

A person who is younger than 18 years old with hearing loss should have a medical evaluation by a doctor, preferably an ENT, before buying a hearing aid. The purpose of a medical evaluation is to identify and treat medical conditions that may affect hearing but that a hearing aid won't treat on its own.

Following the medical evaluation and if appropriate, the doctor will provide a written statement that the hearing loss has been medically evaluated and the person is a candidate for a hearing aid. The doctor may refer the person to an audiologist for a hearing aid evaluation, which is different from the medical evaluation and is intended to identify the appropriate hearing aid.

The audiologist will conduct a hearing aid evaluation to assess the person's ability to hear with and without a hearing aid. This will enable the audiologist to select and fit a hearing aid for the person's individual needs. An audiologist can also provide evaluation and rehabilitation since, for people younger than 18, hearing loss may cause problems in language development and educational and social growth. An audiologist is qualified by training and experience to assist in the evaluation and rehabilitation of hearing loss in people younger than 18.

# Table of Contents

Hearing aid information .....	2
FDA warnings and cautions (US only) .....	3
Introduction .....	8
Getting to know your hearing aid .....	11
Preparing your hearing aids for use .....	15
Placing your hearing aids in your ears .....	19
Removing your hearing aids from your ears .....	23
Using your hearing aids .....	25
Advanced options .....	34
Cleaning and caring for your hearing aids .....	41
Wireless accessories .....	52
Tinnitus Management .....	54
General warnings and cautions .....	63
Cyber security warnings .....	66
Troubleshooting .....	67
Regulatory information .....	69
Technical specifications .....	76
Additional information .....	82

# Introduction

Thank you for choosing ReSound hearing aids. We recommend that you use your hearing aids every day.



**NOTE:** Read this booklet carefully BEFORE using your hearing aids.

## Intended purpose

- The hearing aid is intended to compensate for hearing impairment by amplifying and transmitting sound to the ear.

## User profile

- The hearing aid is intended to be used by adults and children 12 years of age or older.
- The hearing aid is intended to be used by lay persons.
- The hearing aid is intended to be fitted by qualified hearing care professionals.

## Therapeutic indications

- Sensorineural, conductive, or mixed hearing loss.

## Contraindications

A hearing care professional should advise a prospective hearing aid user to consult promptly with a licensed physician (preferably an ear specialist) before dispensing a hearing aid, if the hearing aid dispenser determines through inquiry, actual observation, or review of any other available information concerning the prospective user, that the prospective user has any of the following conditions:

- Visible congenital or traumatic deformity of the ear.



- History of active drainage from the ear within the previous 90 days.
- History of sudden or rapidly progressive hearing loss within the previous 90 days.
- Acute or chronic dizziness.
- Unilateral hearing loss of sudden or recent onset within the previous 90 days.
- Audiometric air-bone gap equal to or greater than 15 dB at 500 Hertz (Hz), 1000 Hz, and 2000 Hz.
- Visible evidence of significant cerumen accumulation or a foreign body in the ear canal.
- Pain or discomfort in the ear.

## Side effects

If you experience side effects, contact your hearing care professional. Possible side effects from wearing a hearing aid may be:

- Dizziness
- Tinnitus
- Perceived worsening of hearing loss
- Nausea
- Skin reaction
- Ear wax accumulation

## Symbols



**WARNING:** Points out a situation that could lead to serious injuries.



**CAUTION:** Indicates a situation that could lead to minor and moderate injuries.



**NOTE:** Advice and tips on how to handle your hearing aid better.



Follow instructions for use.



Equipment includes an RF transmitter.



Product is a Type B applied part.



Date of manufacture.



Do not dispose of your hearing aids and batteries with ordinary household garbage. Your hearing aids and batteries should be disposed of at sites intended for electronic waste or returned to your hearing care professional for safe disposal.

Please ask your local hearing care professional about the disposal of your hearing aid.

NOTE: There may be specific regulations in your country.



Legal manufacturer.



Medical Device.



By prescription only (US).



Complies with ACMA requirements.

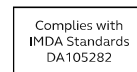

Complies with IMDA requirements.



Unique Device Identification.

# Getting to know your hearing aid

## Model 312

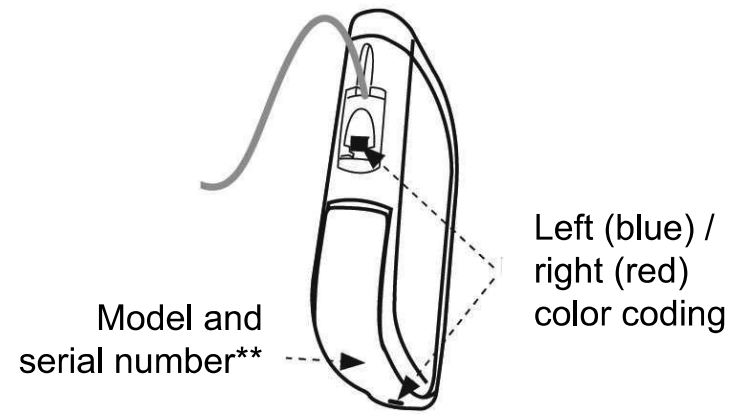
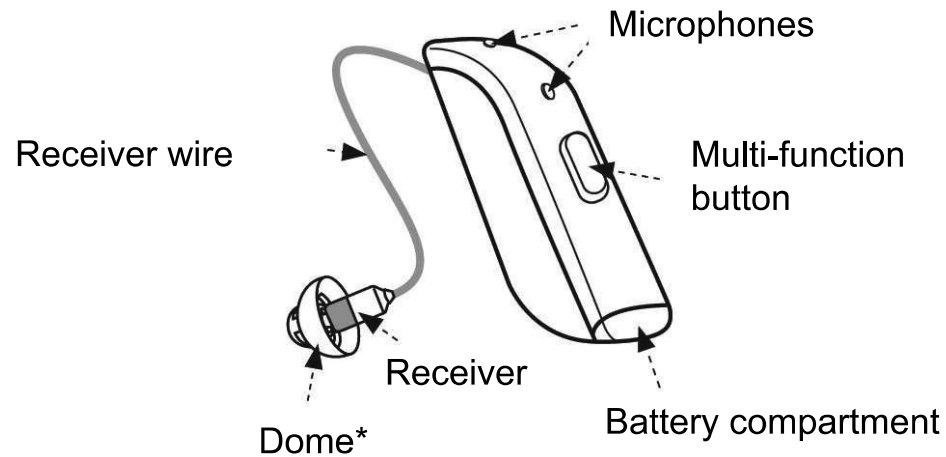

\*Open dome is shown. Your own may look different.

\*\*Inside battery compartment.

## Model 13

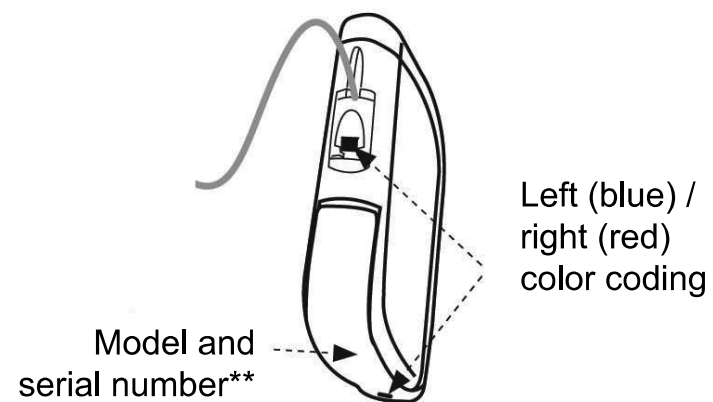
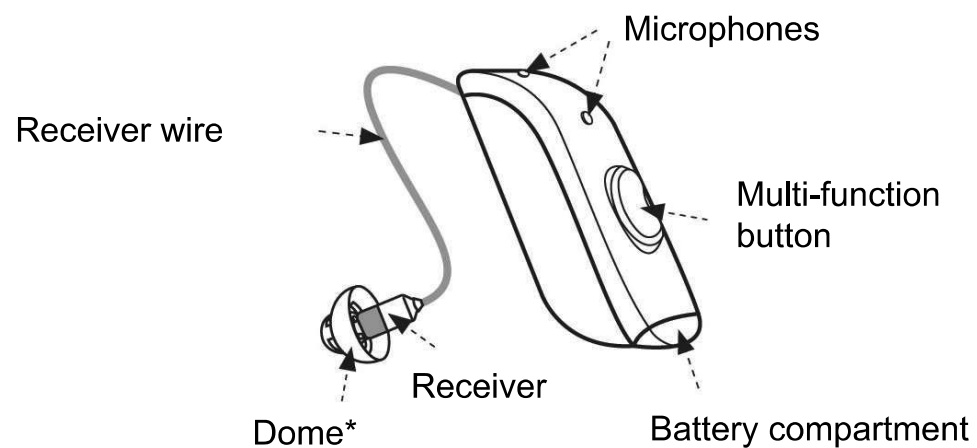

\*Open dome is shown. Your own may look different.

\*\*Inside battery compartment.

## Domes and earmolds

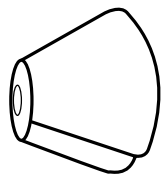

Tulip dome

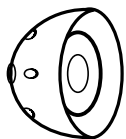

Closed dome

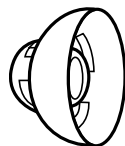

Open dome



Power dome

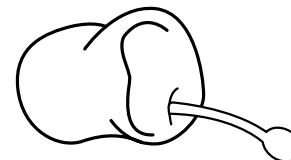

Custom earmold

Domes are all light grey.

## Receivers

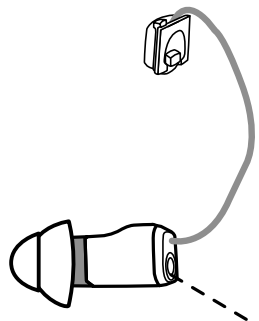

Your receiver may have a microphone as shown here.

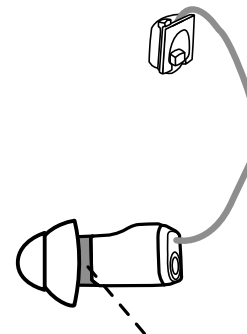

Your hearing aids are color-coded.  
Left = blue. Right = red.

## Sport lock

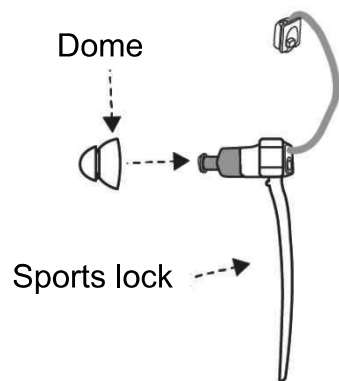

The sport lock helps keep your hearing aids in place when you are physically active.

# Preparing your hearing aids for use

## Battery warnings



### **WARNING:**

- Never put a hearing aid battery in your mouth.
- Keep hearing aid batteries away from pets, children, and people with cognitive, intellectual, or mental health challenges.
- Never swallow batteries nor place them inside any part of the body, as the battery can cause serious injuries. If a battery has been swallowed or placed inside any part of the body, seek immediate medical attention.
- Batteries are harmful for the environment. Therefore, never try to burn them. Dispose of your used batteries according to your country's regulations or return them to your hearing care professional.



### **CAUTION:**

- Batteries may leak. If you are not going to use your hearing aids for a few days, you **MUST** remove the batteries.
- Battery leakage can cause chemical burns. If you are exposed to a battery leakage, rinse immediately with lukewarm water. If you get chemical burns, redness, or skin irritation, seek immediate medical attention.
- Never try to charge zinc-air batteries as this can cause leakage or a small explosion.



**NOTE:** Always use new zinc-air batteries that have a minimum remaining shelf life of one year.

## Inserting the battery into your hearing aid

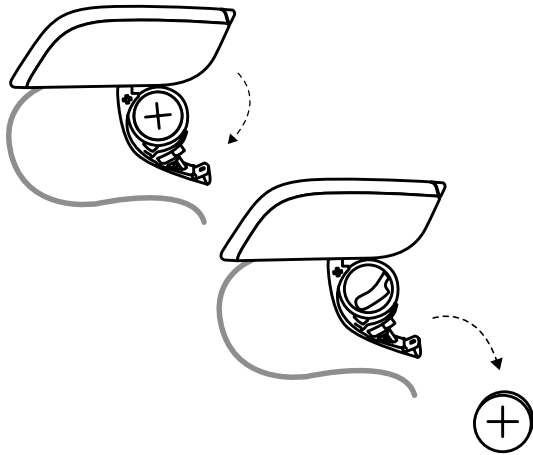

1. Open the battery door with your fingernail. Remove the old battery (if there is one).

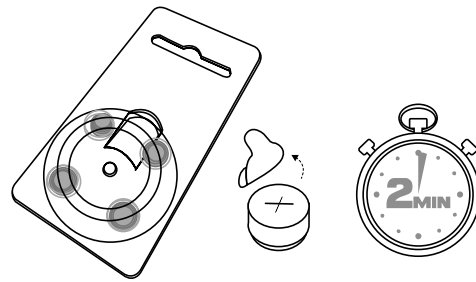

2. Remove the packaging and protective foil from the new battery. Wait for **two minutes** while the battery activates.

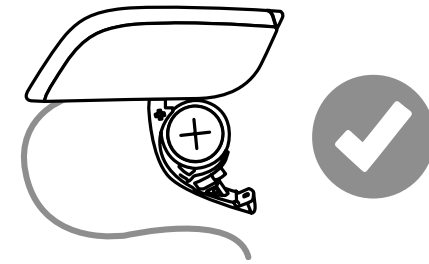

3. Insert the new battery, with the plus (+) sign correctly positioned, into the battery compartment door. **Do not** insert it directly into the hearing aid.

4. Close the battery door.



**NOTE:**

- To save battery power, turn off your hearing aids when they are not in use.



- At night, turn off the hearing aids. Open the battery door completely to allow moisture to evaporate and prolong the hearing aids' life span.

## Low battery alert

When the batteries are low on power, the volume in your hearing aids will momentarily reduce and a melody will play every 15 minutes until there is no more power - then your hearing aids will turn off.





**NOTE:** Keep extra batteries with you.

## Low battery alert when paired with wireless accessories



**NOTE:**

Your batteries will run out faster when you use wireless functions like streaming from your smart device or from your TV with our TV streamer. As the battery power declines, the wireless functions stop working. A short melody will play every five minutes to let you know that the battery power is low. The table below shows the functionality with different battery charge levels.

Battery level	Signal	Hearing aid	Remote control	Streaming
Fully charged		✓	✓	✓
Low	 4 even tones	✓	✓	x
Depleted	 3 even tones and 1 longer tone	✓	x	x

These will work again when you insert a new battery.

# Placing your hearing aids in your ears

## How to tell left from right

Left hearing aid (blue marking)

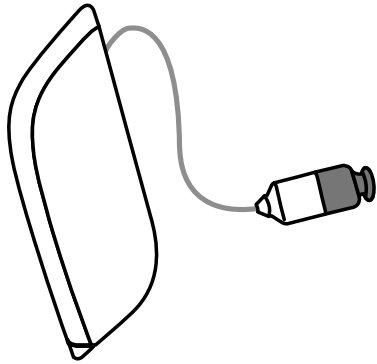

Right hearing aid (red marking)

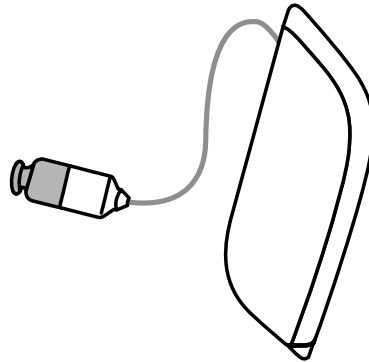

**CAUTION:** If you have two hearing aids, they may each be programmed differently. Do not swap them as this could damage your hearing.

Your hearing aids are color-coded. Left = blue. Right = red.

If your hearing aids are not color coded, ask your hearing care professional to add color coding.

## Inserting the receiver dome into your ear

If your hearing aids have domes, follow these instructions:

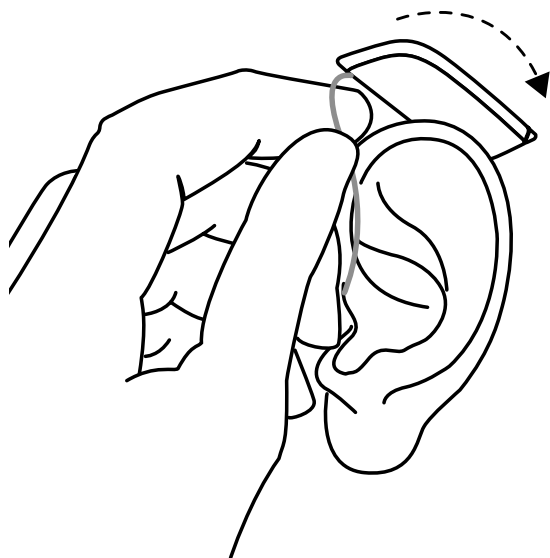

1. Hang the hearing aid over the top of your ear.

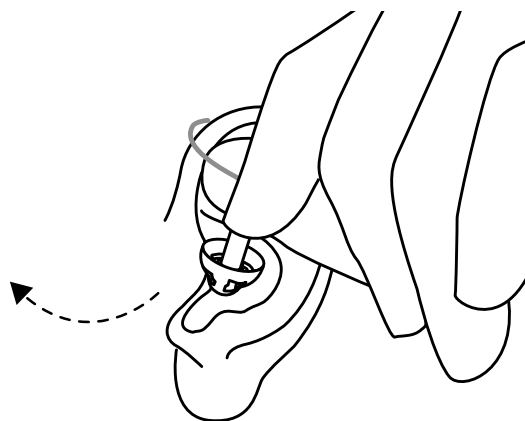

2. Hold the receiver wire where it bends and gently place/push the receiver dome into your ear canal.

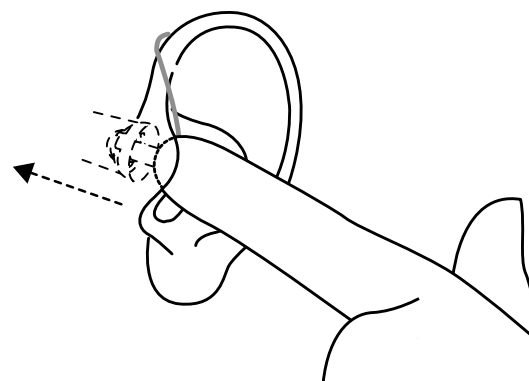

3. Push the dome far enough into your ear canal so that the wire rests against your head. You can check in a mirror.



**NOTE:** To avoid whistling, ensure that the wire, and dome fit correctly into your ear. If you continue to experience whistling, check the troubleshooting guide for other possible reasons and solutions.

## Sport lock

If you are very active, your hearing aids may move from the correct position. To avoid this situation, your hearing care professional can attach and adjust a sports lock to the receiver.

To insert a hearing aid with a sports lock:

1. Insert the hearing aid as usual
2. Tuck the sports lock into the bottom of the concha (the part of your ear just outside the ear canal).



**NOTE:** Sports locks may become stiff, brittle, or discolored over time. Contact your hearing care professional for a replacement. Your hearing care professional will help you replace it.

## Inserting earmolds into your ears

If your hearing aids have earmolds, follow these instructions:

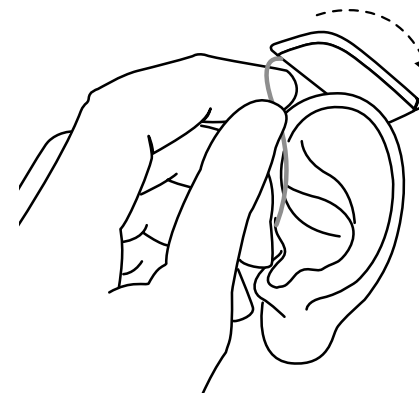
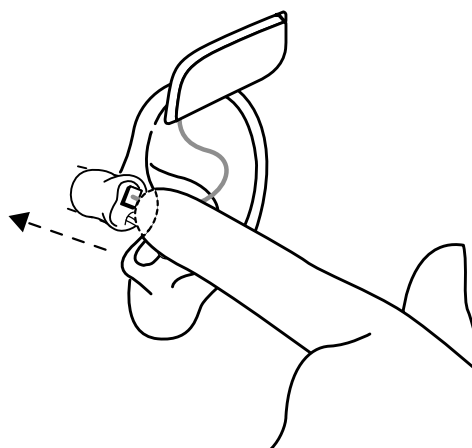
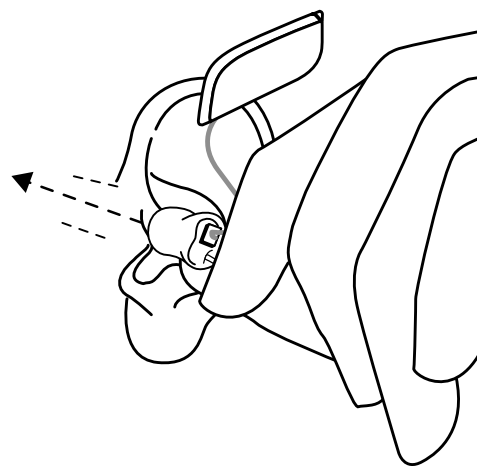

1. Hold the earmold between your thumb and index finger and position the sound outlet into your ear canal.
2. Slide the earmold into your ear with a gentle, twisting movement. Move the earmold up and down and press gently. Opening and closing your mouth may be helpful.
3. Place the hearing aid behind your ear and ensure it is secure. When properly inserted, your hearing aids should fit snugly and comfortably.



**NOTE:** When inserting an earmold, it may help to pull your ear up and back with the opposite hand.

# Removing your hearing aids from your ears

## Removing receiver domes from your ears

If your hearing aids have domes, follow these instructions:

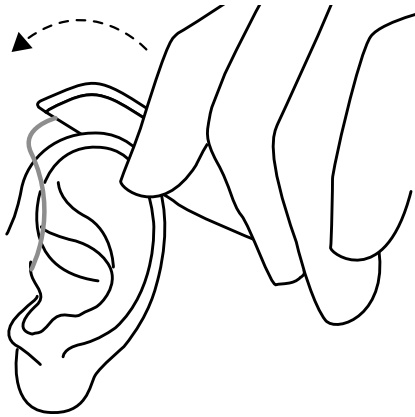

1. Lift the hearing aid off your ear.

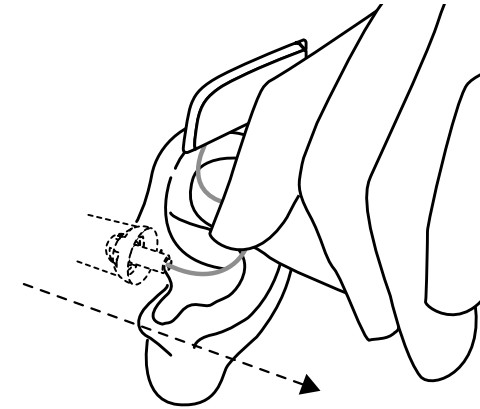

2. Hold the receiver wire with your thumb and forefinger where it bends and pull the dome out of your ear canal.

## Removing earmolds from your ears

If your hearing aids have earmolds, follow these instructions:

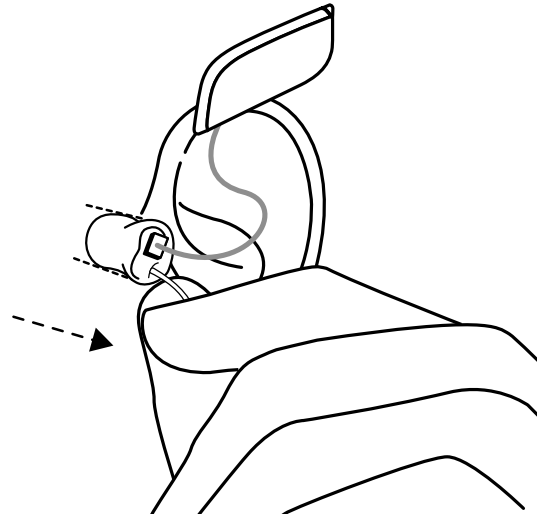
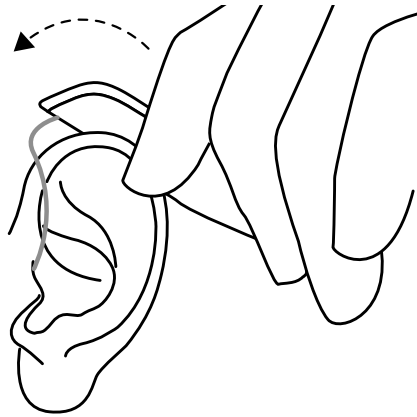

1. Lift the hearing aid from behind your ear. Let it hang beside your ear momentarily.
2. Using your thumb and index finger, gently pull the earmold (not the hearing aid or the wire) loose from your ear. If your earmold has a removal cord, pull it gently to assist. The removal cord is a separate line that is additionally attached to the earmold if requested. Remove the earmold completely by twisting it gently.



# Using your hearing aids

## Turning your hearing aids on and off

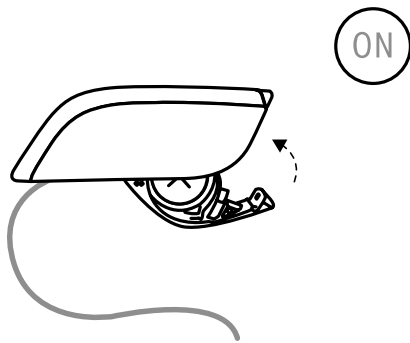

To turn your hearing aid on, close the battery door.

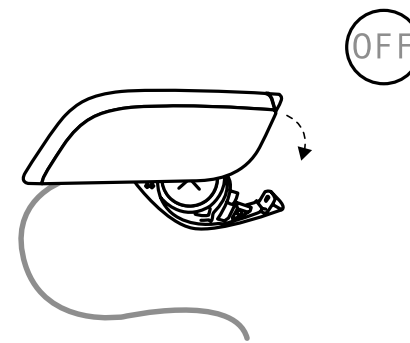

To turn the hearing aid off, open the battery door (with your fingernail).

## Smart Start

Smart Start delays the time before your hearing aid turns on after you close the battery door. With this function activated, you will hear a beep for each second of the delay period (either 5 or 10 seconds).

Smart Start delays when sound comes through your hearing aid. It gives you time to put on the hearing aid without whistling or other issues.



**NOTE:** If you do not want to use this function, ask your hearing care professional to deactivate it.

## Listening programs

Your hearing care professional can activate one or more listening programs in your hearing aids. These programs can help you in specific situations. Ask your hearing care professional about which programs could be useful for you.

Programs	Use
All-Around	The best option if you want only one program.
Front Focus/Ultra Focus	For use in very noisy places (more focused than the Restaurant program).
Restaurant	For use in noisy places such as restaurants and social gatherings.
Music	For listening to music.
Acoustic phone	A special program for phone conversations.
Outdoor	For outdoor use (to reduce wind noise).
Telecoil phone + Mic	For use if you have a phone with a telecoil.
Telecoil loop + Mic	For use in places that have a teleloop system such as theaters and places of worship.

## Apps

We have an app that you can use to control your hearing aids. You can use the app to adjust the volume, change programs and stream from another device. See "Advanced options", page 34.

## Using the push button



The "312" models have a push button.

### Changing programs

- Push the button to switch from one program to the next. Your hearing aids will beep to confirm the change. The number of beeps indicates which program you have selected.
- To get back to the default listening program, keep scrolling, or turn your hearing aids off and on again.



**NOTE:** If you have two hearing aids with synchronization enabled, changing the program on one hearing aid automatically applies the change to the second hearing aid as well.

### Streaming sound to your hearing aids

Press the button and keep it pressed for three seconds. Your hearing aids will start streaming from the audio device you have chosen.

Before you can stream to your hearing aids, you must pair them with your audio device. For more information on how to do this, consult the user's instructions for your audio device.





## Using the multi-function button

The "13" models have a multi-function button.

It is called a multi-function button because it has several functions: you can change program, control volume, and activate streaming.

### Changing programs

- To change the program, press the top of the multi-function button and hold it for three seconds. Your hearing aids will beep to confirm the change. The number of beeps indicates which program you have selected.
- Continue pressing it to scroll through the programs available to you.
- To get back to the default listening program, keep scrolling, or turn your hearing aids off and on again.



**NOTE:** If you have two hearing aids with synchronization enabled, changing the program on one hearing aid automatically applies the change to the second hearing aid as well.

This feature can also be configured to allow you to use one hearing aid to increase volume and the other to decrease volume. Any increase or decrease made on one hearing aid will also apply to the other to ensure the volume is the same in both hearing aids.

Your hearing care professional can change the default settings and fill in the table below to record the new settings:

<b>Button action</b>	<b>Default setting</b>	<b>New setting</b>
Short press up	Increase volume	
Short press down	Decrease volume	
Long press up (3 seconds)	Change program	
Long press down (3 seconds)	Activate streaming	

## Controlling the volume

If your hearing care professional has activated your volume control, follow these instructions:

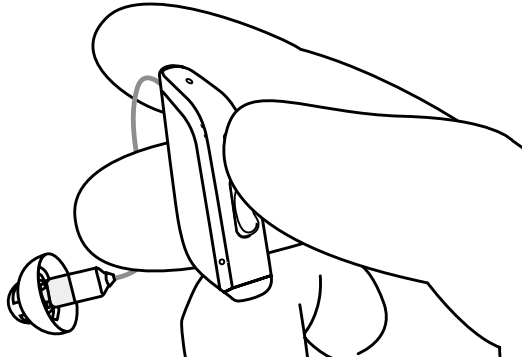

To increase the volume, briefly press the **top** part of the button.

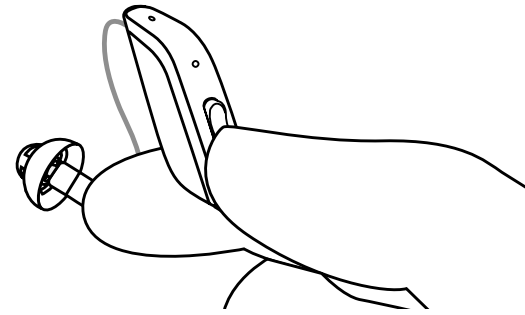

To reduce the volume, briefly press the **bottom** part of the button.

## Streaming sound to your hearing aids

Press the bottom part of the button and keep it pressed for three seconds. Your hearing aids will start streaming from the audio device you have chosen.

Before you can stream to your hearing aids, you must pair them with your audio device. For more information on how to do this, consult the user's instructions for your audio device.

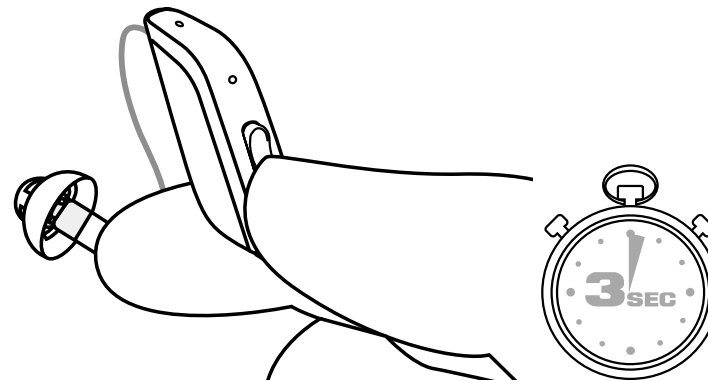

## Telecoil (Optional)

Your hearing aid may have a telecoil. The Telecoil function may help to improve understanding of speech with Hearing Aid Compatible (HAC)<sup>1</sup> telephones and in theaters, movie theaters, houses of worship, etc. that have a teleloop installed.

When you select the Telecoil function, your hearing aid picks up signals from the teleloop or your HAC telephone. Your hearing care professional can activate the Telecoil program.



### NOTE:

- The telecoil does not work without a teleloop (i.e., an induction loop) or an HAC telephone.
- If you are having trouble hearing with the telecoil, ask your hearing care professional to modify the function.
- If there is no sound from your hearing aids in a teleloop system with an active Telecoil function, the teleloop system may not be turned on or may not be operating correctly.
- The sound from the teleloop and the hearing aid microphones can be mixed according to your preference. Ask your hearing care professional for more details.
- When you want to stop the telecoil function, change to another listening program.

---

<sup>1</sup>Some smartphones are hearing aid compatible (HAC). The HAC phone establishes a small hearing loop that your hearing aids can connect to. The telecoil picks up the HAC phone's signal and converts it to sound.

## Using a telephone

Your hearing aid allows you to use your telephone as you normally do. Finding the optimal position for holding the phone may require practice.

The following suggestions may be helpful:

1. Hold the telephone up to your ear canal or hold it close to the hearing aid microphones as illustrated.
2. If you hear whistling, try holding the telephone in the same position for a few seconds. The hearing aid may be able to cancel the whistling.
3. You can also try holding the telephone slightly away from the ear.

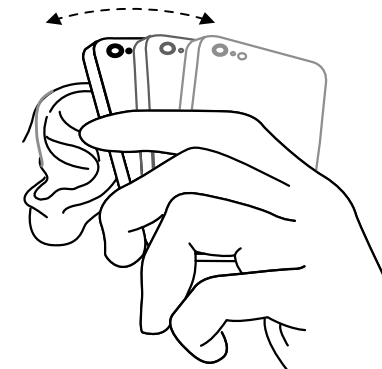

### NOTE:

- If you have a mobile device, you can pair it to connect directly to your hearing aids. See "Advanced options", page 34.
- If you find it difficult to get a good result while using your mobile phone, your hearing care professional can give you advice on available wireless accessories to enhance listening capabilities. See also "Wireless accessories", page 52.
- Depending on your needs, your hearing care professional may activate a function specifically for telephone use.



## **Mobile phones**

Your hearing aids comply with the most stringent Standards of International Electromagnetic Compatibility. Any degree of disturbance can be due to the nature of your particular mobile phone or of your wireless telephone service provider.

# Advanced options

## Using your hearing aids with iPhone, iPad, and iPod touch (optional)

Your hearing aids are Made for iPhone®, iPad®, and iPod touch®, which allow for direct audio streaming, including hands-free phone calls from the latest iPhone and iPad models<sup>1</sup>, and control from these mobile devices.

## Streaming from an Android™ smartphone

Some Android smartphones can stream audio, including phone calls, directly to your hearing aids. Your device must be running Android 10 or newer and it must have the Android Streaming for Hearing Aids feature as well.

 **NOTE:** For assistance with pairing and using these products with your hearing aids, contact your hearing care professional.

## Controlling your hearing aid with the mobile device app (optional)

The ReSound Smart 3D™ app sends and receives signals to and from the hearing aids via smartphones.

- Use only the ReSound Smart 3D™ app with your hearing aids.
- Do not disable app notifications.
- Install updates to keep the app working correctly.

---

<sup>1</sup>Hands-free calls are compatible with iPhone 11 or later, iPad Pro 12.9-inch (5th generation), iPad Pro 11-inch (3rd generation), iPad Air (4th generation), and iPad mini (6th generation), with software updates iOS 15.3 and iPadOS 15.3 or later.

- To get a printed version of the smartphone app user's guide, please refer to information on the back page of this user's guide or consult customer support.



**NOTE:**

- For assistance with pairing and using these products with your hearing aids, contact your hearing care professional or visit our support site.
- If your Bluetooth® enabled Android smartphone does not stream directly to your hearing aids, you can use our ReSound Phone Clip+ for streaming capabilities.

## **ReSound Assist and ReSound Assist Live (optional)**

### **ReSound Assist**

If you have signed up to use ReSound Assist available with your hearing aids, you can allow your hearing aids to be adjusted remotely without having to visit your hearing care professional.

All you need is a compatible mobile device with internet enabled. This allows you to:

- Request assistance remotely to adjust your hearing aids to be a better fit for you.
- Keep your hearing aids up to date with the latest software to ensure the best performance possible.

This service only works if your mobile device is connected to the internet. Your hearing care professional will provide information regarding this option, and how it works with the ReSound Smart 3D™ app.

For optimum performance, make sure the hearing aids are connected to the ReSound Smart 3D™ app and placed close to the iPhone, iPad, iPod touch, or the Android smartphone before applying the changes.



**NOTE:** Your hearing aids shut down during the installation and update process.

### **ReSound Assist Live**

This service also includes ReSound Assist Live. With this service you can get face-to-face assistance from your hearing care professional from home.



### **Phone Now (optional)**

If you place a magnet on the telephone receiver, your hearing aids will automatically switch the telephone program on when the receiver is close to your ear.

When you remove the receiver from your ear, the hearing aids automatically return to the previous listening program.



**NOTE:** Ask your hearing care professional to enable Phone Now in your hearing aids.

## Phone Now warnings



### **WARNING:**

- Swallowing a magnet can be harmful to your health. If a magnet is swallowed, seek immediate medical attention.
- Keep magnets out of reach of pets, children, and people with cognitive, intellectual, or mental health challenges.
- The Phone Now magnet may affect sensitive medical devices/electronic systems. Seek advice from the manufacturers regarding appropriate safety measures when using the Phone Now solution near the sensitive device/equipment (pacemakers and defibrillators) in question. If the manufacturer cannot issue a statement, we recommend keeping the magnet or a telephone equipped with the magnet 30 cm (12”) away from magnetically sensitive devices (e.g., pacemakers).

## Placing the Phone Now magnet

Place the magnet on your telephone receiver as follows:

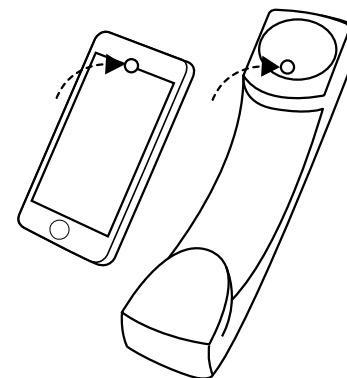
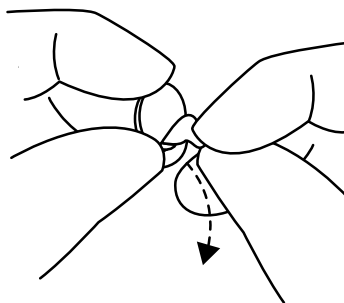
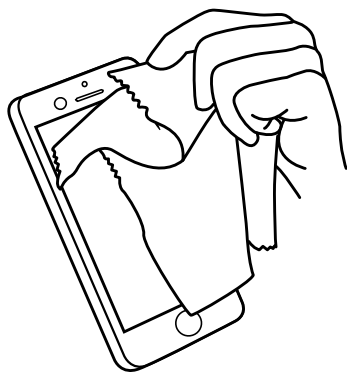

1. Clean the surface thoroughly. Use a recommended cleaning agent.
2. Remove the foil from the magnet.
3. Place the magnet on the phone.



### CAUTION:

- If you experience frequent signal loss or noise during calls, move the Phone Now magnet to another place on the telephone receiver.
- Only use magnets supplied by ReSound.

## How to use Phone Now

1. Lift the telephone to your ear.
2. When you hear a short melody, the phone program is active.



**NOTE:**

- You may need to move the telephone receiver slightly to find the best position for reliable Phone Now activation and a good hearing experience on the telephone.
- If your hearing aids have the Comfort Phone functionality enabled, the hearing aid on the non-phone ear automatically attenuates.
- Do not cover the phone loudspeaker opening with the magnet.
- If the function does not work to your satisfaction, moving the magnet to another position may improve ease of use and comfort.
- If your hearing aids do not switch to the telephone program consistently, try repositioning the magnet or adding additional magnets.

## Flight Mode / Wireless Communication Off Mode (optional)

Your hearing aids can receive wireless signals. For example, they can be controlled from your mobile device or remote control. Information transmission can also take place between your hearing aids. However, in some areas you are requested to turn off wireless communication.



### CAUTION:

- This hearing aid contains a radio frequency transmitter. When boarding a flight, follow airline instructions and turn off hearing aid wireless functionality when and as directed.
- Turn off hearing aid wireless functionality when this is required.



**NOTE:** You must follow the processes below for both hearing aids, even if synchronization is enabled.

### Turning off wireless communication (activating Flight Mode)

1. Open and close the battery door on each hearing aid three times within 10 seconds.
2. A 10-second double tone (♪♪) means the hearing aid is now in Flight Mode.

It is important to wait an additional 15 seconds after you activate Flight Mode before opening and closing the battery compartment again for any reason. If you open and close the battery compartment during this 15 second window, wireless communication will reactivate.

### Activating wireless communication (turning off Flight Mode)

1. Open and close the battery door on each hearing aid once.
2. Wireless communication will be activated after 10 seconds.



# Cleaning and caring for your hearing aids

## Cleaning tools

These cleaning tools come with your hearing aids:

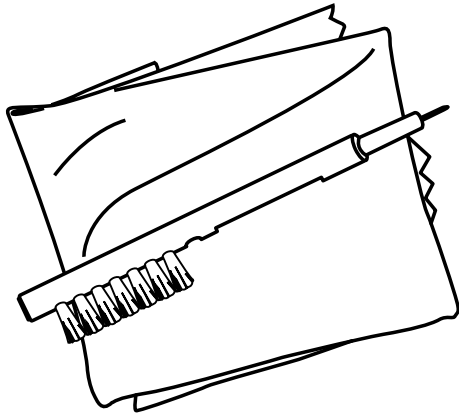

1. Soft cloth.
2. A brush with a battery magnet.

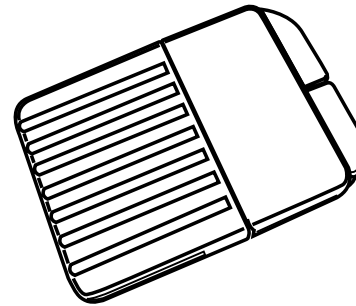

Your hearing care professional may give you a set of wax filters.

## General instructions for care and maintenance

**i** **NOTE:** To ensure you get the highest quality experience and longest useful lifetime out of your hearing aids, it is important to clean and care for them.

Keeping your hearing aids in perfect working order is easily done. Just follow these steps:

1. When you remove your hearing aids, turn them off by opening the battery doors completely. This helps to dry them out.
2. After removing your hearing aids, wipe them with a soft cloth to keep them clean and dry.
3. If you use a drying agent, only use recommended products.
4. Apply cosmetics, perfume, after-shave, hairspray, lotions etc. **BEFORE** putting on your hearing aids. These products can damage or discolor your hearing aids.
5. Never immerse your hearing aids in liquid.
6. Keep your hearing aids away from excessive heat and direct sunlight.
7. Do not swim, shower, or take steam baths while wearing your hearing aids.
8. The device is certified to IP68 for water and dust resistance:
  - The device has **IP6X** protection against ingress of dust. Avoid the device getting exposed to extensive dust.
  - The device has **IPX8** protection against water getting in. Avoid the device getting exposed to water, and do not swim, shower, or use a sauna while wearing the device.

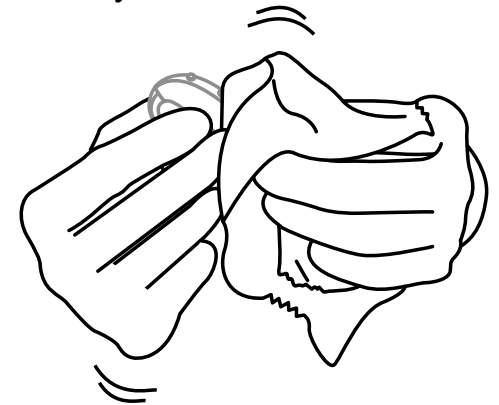



## CAUTION:

- Never use alcohol or other cleaning solutions to clean your hearing aids. This can damage your hearing aids and may cause a skin reaction.
- Ear wax or other residue on your hearing aids can cause an infection. To avoid this, clean your hearing aids as instructed.

## Daily care and maintenance

It is important to keep your hearing aids clean and dry on a daily basis. Use the supplied cleaning tools.

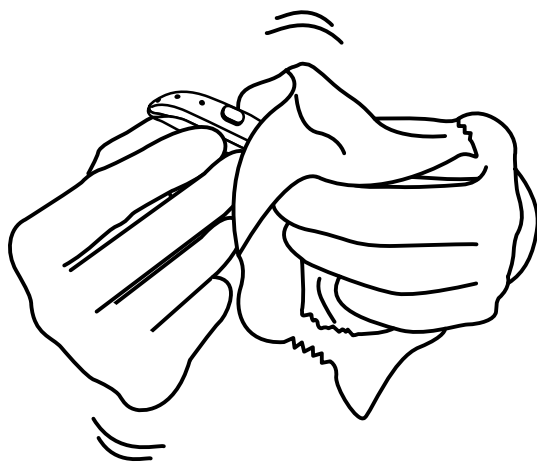

1. Wipe your hearing aids with the cloth.

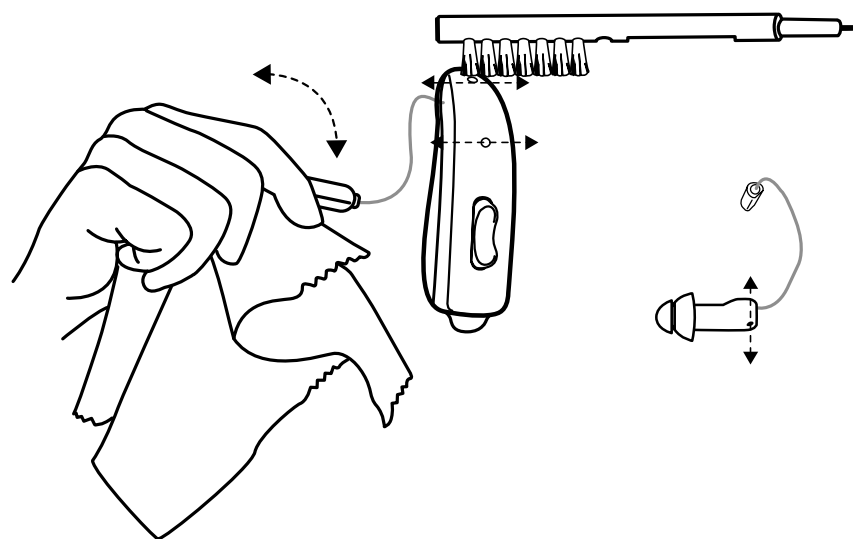

2. Swipe the small brush across the microphones. If your receiver has a microphone, remember to brush that one as well.



**NOTE:**

- Never try to put the bristles of the small brush or the cleaning wire into the microphone inlets. This can damage your hearing aids.
- Do not use water to clean your receiver wires and domes or earmolds.
- Use a soft, dry cloth to wipe your receivers and domes or earmolds clean.

## Changing your hearing aid domes

We recommend that your hearing care professional shows you how to change domes. You should change your domes every 3 months or more often according to the advice of your hearing care professional. Incorrect dome replacement can result in a dome being left in your ear when you remove your hearing aid.



**CAUTION:**

- If you suspect that you have a dome stuck in your ear, consult your hearing care professional. These objects can be harmful and can cause an infection in your ear.
- Use only accessories intended for use with your hearing aids. Consult your hearing aid professional for more information.

## Standard domes

The illustrations show an open dome, but the procedure is the same for all other domes. Follow these instructions to replace your domes.

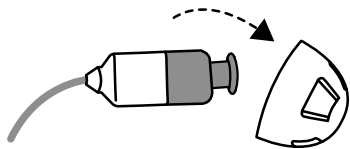

1. Remove the used dome by pulling it off the receiver and then discard it. This may require a bit of force.

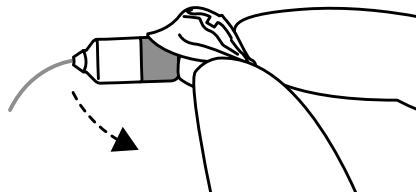

3. Check that the dome is securely mounted by carefully lifting the lower part of the dome and verifying that the collar completely covers the ribbed end of the receiver.

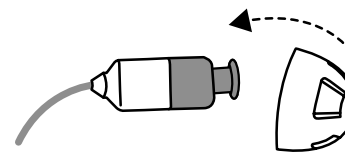

2. Push the new dome over the ribbed end of the receiver.

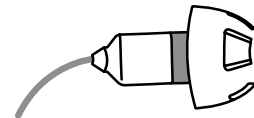

4. When placed correctly, the dome will appear slightly angled.

## Tulip domes

To change a tulip dome, follow these instructions:

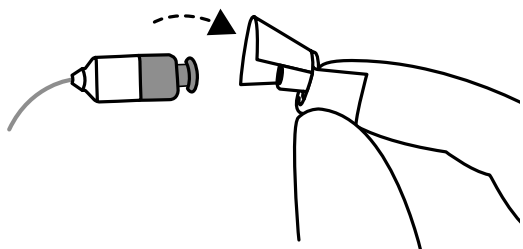

1. Remove the used dome by pulling it off the receiver and then discard it. This may require a bit of force.

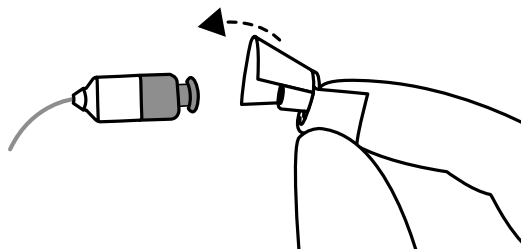

2. Push the largest petal back, then press the tulip dome over the ribbed end of the receiver.

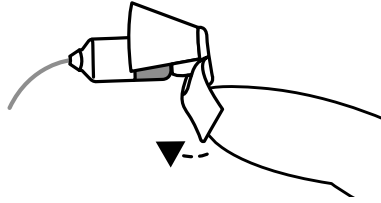
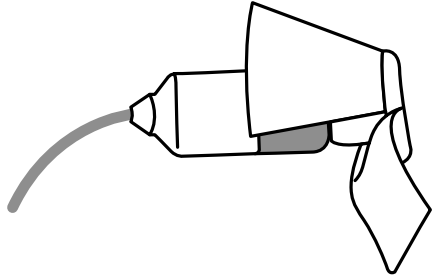

3. Check that the tulip dome is securely mounted by verifying that the collar completely covers the ribbed end of the receiver.
4. Push the larger tab forward.

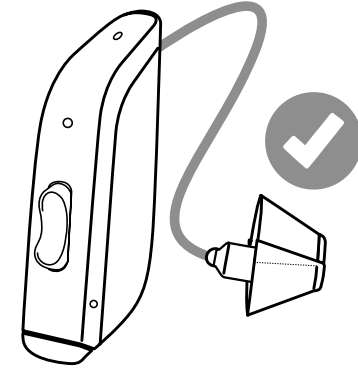

This illustration shows a correctly mounted tulip dome. Ensure the large petal is outside the small petal.

## Changing the wax filter

The wax filter helps keep earwax away from the components of the hearing aid. You must replace it on a regular basis. Consult your hearing care professional for advice on how often you need to change them. It will depend on how much wax your ears produce.

If you wear a dome, remove it before following this process for replacing the wax filter. You will need your box of wax filter tools.

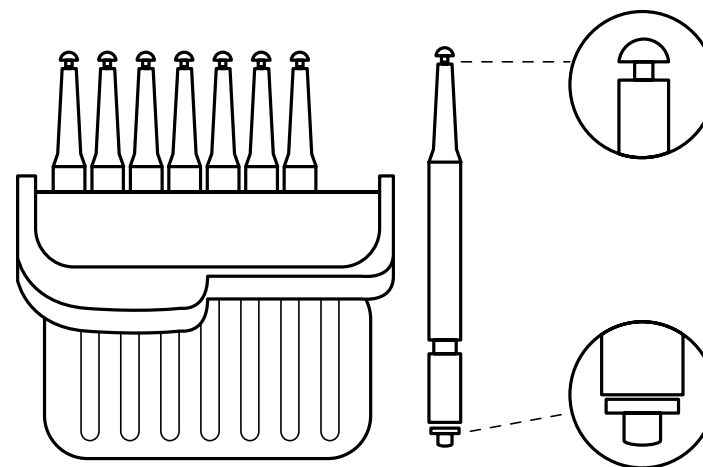

Box of 8 wax filter tools.

The wax filter tool has two functions: a removal tip to collect the used filter, and a replacement tip with a white filter.



## Removing the old wax filter

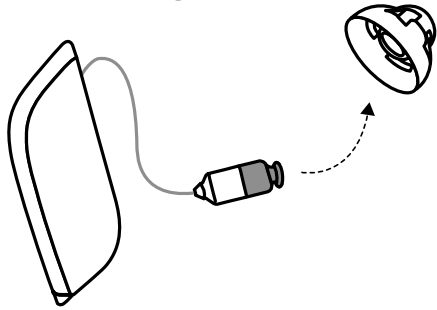

1. Remove the dome from the receiver.

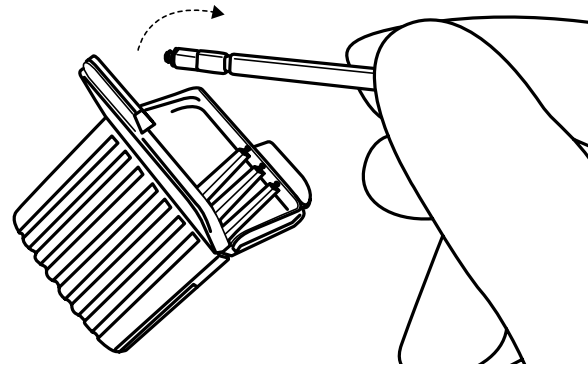

2. Open the wax filter case and take out one of the tools. Each tool has a small hook in one end and a new wax filter in the other.

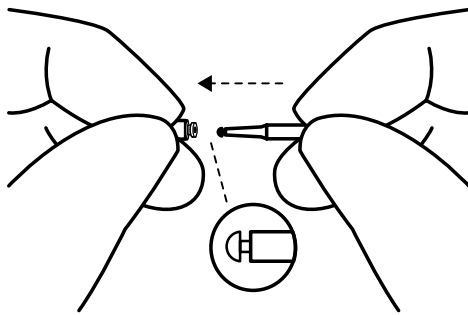

3. Insert the removal tip into the used wax filter and then pull the tool straight out. It is important to pull it straight and not on an angle.

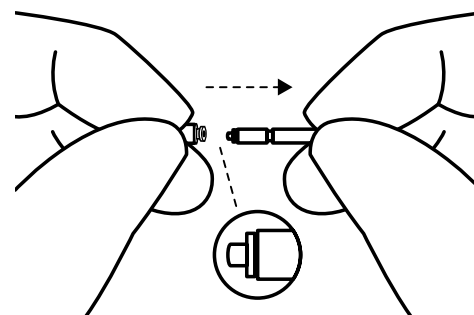

## Inserting the new wax filter

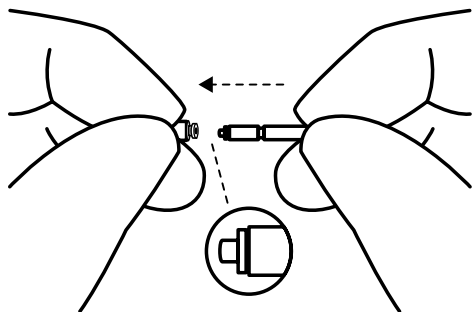

1. Insert the other end of the tool into the sound outlet (the end with the replacement filter).

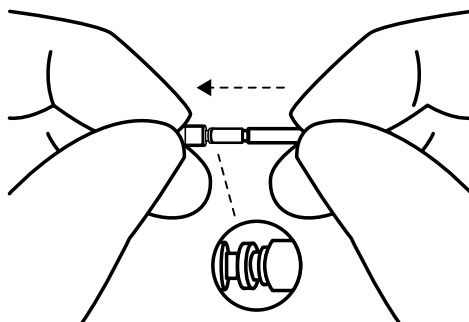

2. Gently press the replacement straight into the sound outlet until the outer ring is touching the sound outlet.

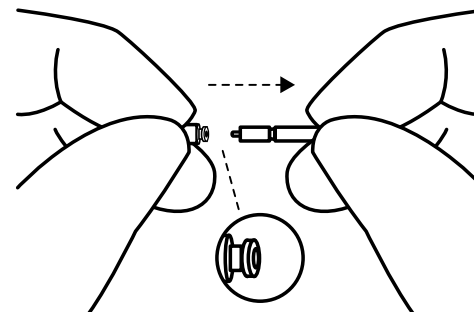

3. Pull the tool straight out. Your new wax filter will remain in place. Re-attach your dome or a replacement dome.

## Storing your hearing aids

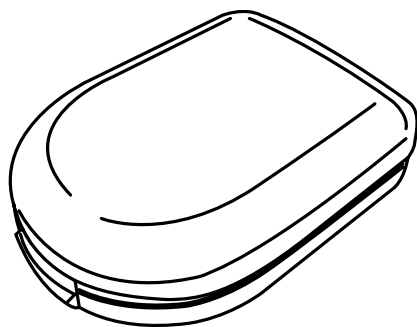

1. The best storage for your hearing aids is the case they came in.



### **WARNING:**

- Never put a hearing aid battery in your mouth.
- Keep hearing aid batteries away from pets, children, and people with cognitive, intellectual, or mental health challenges.
- Never swallow batteries nor place them inside any part of the body, as the battery can cause serious injuries. If a battery has been swallowed or placed inside any part of the body, seek immediate medical attention.

2. When they are not being worn, keep your hearing aids dry by leaving the battery doors open.



# Wireless accessories

Our wireless eco-system features a comprehensive range of seamlessly integrated wireless accessories. These let you stream high quality stereo sound and speech directly to your hearing aids.

## Available wireless accessories and their features

- **A TV streamer** streams audio from a TV and most other audio sources to your hearing aids at a volume that suits you.
- **A basic remote control** adjusts volume, mutes your hearing aids, and changes programs.
- **An advanced remote control** adjusts volume, mutes your hearing aids, changes programs, and displays your settings.
- **A phone clip** streams phone conversations and stereo sound to both hearing aids and doubles as a remote control.
- **A body-worn microphone** is a microphone that can be worn by others. It improves speech comprehension in noisy situations.
- **A wireless microphone** works like the **body-worn microphone**, but doubles as a table microphone. Furthermore, it has a built-in telecoil that allows it to connect with a teleloop system, a connector for a FM receiver, and a mini-jack input for wired streaming of audio from a computer or music player.
- **An app** which you can install on your mobile device to enable streaming and control directly from your mobile device. See "Advanced options", page 34.

## Accessing wireless accessories

To access a wireless device that has already been paired with your hearing aids, press the push button for maximum 2 seconds. The hearing aid will emit a sound to confirm the connection.

For information on how to pair your hearing aids with a wireless accessory, see the user guide for the relevant wireless accessory.

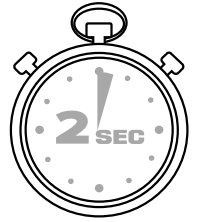

### NOTE:

- Please contact your hearing care professional for an overview of compatible wireless accessories that are approved by GN ReSound A/S.
- You should only use ReSound wireless accessories with your wireless hearing aids.

# Tinnitus Management

## Tinnitus Sound Generator module

Your ReSound hearing aid includes the Tinnitus Sound Generator (TSG) module, a tool for generating sounds to be used in tinnitus management programs to temporarily relieve suffering from tinnitus. The TSG can generate sounds adjusted to the specific therapeutic needs and your personal preference as determined by your doctor, audiologist, or hearing care professional. Depending on the selected hearing aid program and the environment you are in, you will sometimes hear the therapeutic sound resembling a continuous or fluctuating noise.

## Indications for use of the TSG module

The Tinnitus Sound Generator module is a tool to generate sounds to be used in a Tinnitus Management Program to temporarily relieve patients suffering from Tinnitus. The target population is primarily the adult population over 18 years of age. This product may also be used for children 12 years of age or older. However, children and physically or mentally disabled users will require training by a doctor, audiologist, hearing care professional, or their guardian in the insertion and removal of the hearing aid containing the TSG module.

## For healthcare professionals

The Tinnitus Sound Generator module is targeted for healthcare professionals who are treating patients suffering from Tinnitus, as well as conventional hearing disorders. The initial fitting of the Tinnitus Sound Generator module must be done during an in-office visit by a hearing professional participating in a Tinnitus Management Program. If deemed feasible by the hearing professional, subsequent fittings of the Tinnitus Sound Generator module may be performed remotely and in real time while having live communication via live audio, video, and chat on the user's dedicated app.

## User instructions for the TSG module

### Description of the device

The Tinnitus Sound Generator (TSG) Module is a software tool that generates sounds to be used in tinnitus management programs to temporarily relieve suffering from tinnitus.

### Explanation of how the device functions

The TSG module is a frequency and amplitude shaped white-noise generator. The noise signal level and frequency characteristics can be adjusted to the specific therapeutic needs as determined by your doctor, audiologist, or hearing care professional.

Your doctor, audiologist, or hearing care professional can modulate the generated noise in order to make it more pleasant. The noise can then resemble, for example, breaking waves on a shore.

Modulation level and speed can also be configured to your likes and needs. An additional feature can be enabled by your hearing care professional that allows you to select predefined sounds that simulate sounds from nature, such as breaking waves or running water.

If you have two wireless hearing aids that support ear-to-ear synchronization, this functionality can be enabled by your hearing care professional. This will cause the Tinnitus Sound Generator to synchronize the sound in both hearing aids.

If your tinnitus only troubles you in quiet environments, your doctor, audiologist, or hearing care professional can set the TSG Module so that it becomes audible exclusively in such surroundings. The overall sound level can be adjusted using an optional volume control. Your doctor, audiologist, or hearing care professional will review with you the need for having such a control.

For hearing aids where ear-to-ear synchronization is enabled, your hearing care professional can also enable environmental monitoring synchronization so that the TSG noise level is automatically adjusted simultaneously in both hearing aids dependent on the background sound level. Additionally, since the hearing aid has a volume control, the background noise level monitored by the hearing aid and the volume control can be used simultaneously to adjust the generated noise level in both hearing aids.

## The scientific concepts that form the basis for the device

The TSG module provides sound enrichment with the aim of surrounding the tinnitus sound with a neutral sound which is easily ignored. Sound enrichment is an important component of most approaches to tinnitus management, such as tinnitus retraining therapy (TRT).

To assist habituation to tinnitus, this needs to be audible. The ideal level of the TSG module, therefore, should be set so that it starts to blend with the tinnitus, and so that you can hear both your tinnitus as well as the sound used.

In a majority of instances, the TSG module can also be set to mask the tinnitus sound, so to provide temporary relief by introducing a more pleasant and controllable sound source.

## TSG volume control

The sound generator is set to a specific loudness level by the hearing care professional. When switching the sound generator on, the volume will have this optimal setting. Therefore, it might not be necessary to control the volume (loudness) manually. However, the volume control provides the ability to adjust the volume, or amount of stimulus, to the liking of the user. The tinnitus sound generator volume can only be adjusted within the range set by the hearing care professional.

The volume control is an optional feature in the TSG module used for adjusting the sound generator output level.



## Using TSG with smartphone apps

The tinnitus sound generator control via hearing aid push buttons can be enhanced with wireless control from a TSG control app on a smartphone or mobile device. This functionality is available in supported hearing aids when a hearing care professional has enabled the TSG functionality during fitting of the hearing aid.



**NOTE:** To use smartphone apps, the hearing aid must be connected with the smartphone or mobile device.

## TSG - Technical specifications

Audio signal technology: Digital.

### Available sounds

White noise signal which can be shaped with the following configurations:

High-pass filter	Low-pass filter
500 Hz	2000 Hz
750 Hz	3000 Hz
1000 Hz	4000 Hz
1500 Hz	5000 Hz
2000 Hz	6000 Hz
-	8000 Hz

The white noise signal can be modulated in amplitude with an attenuation depth of up to 14 dB.



### Prescription use of this device

The TSG module should be used as prescribed by your doctor, audiologist or hearing healthcare professional. In order to avoid permanent hearing damage, the maximum daily usage depends on the level of the generated sound.

To adjust TSG, please consult your hearing healthcare professional.

Should you develop any side effects from using the sound generator, such as dizziness, nausea, headaches, perceived decrease in auditory function, or increase in tinnitus perception, you should discontinue use of the sound generator and seek medical evaluation.

### **Target population**

The target population is primarily the adult population over 18 years of age. This product may also be used for children 12 years of age or older. However, children and physically or mentally disabled users will require training by a doctor, audiologist, hearing care professional, or their guardian in the insertion and removal of the hearing aid containing the TSG module.

### **Important notice for prospective sound generator users**

A tinnitus masker is an electronic device intended to generate noise of sufficient intensity and bandwidth to mask internal noises. It is also used as an aid in hearing external noises and speech.

Good health practice requires that a person with a tinnitus condition have a medical evaluation by a licensed physician (preferably a physician who specializes in diseases of the ear) before using a sound generator. Licensed physicians who specialize in diseases of the ear are often referred to as otolaryngologists, otologists, or otorhinolaryngologists.

The purpose of medical evaluation is to assure that all medically treatable conditions that may affect tinnitus are identified and treated before the sound generator instrument is used.

The sound generator instrument is a tool to generate sounds to be used with appropriate counseling and/or in a tinnitus management program to relieve patients suffering from tinnitus.

## Warning information



### **WARNING:**

- Sound generators can be dangerous if improperly used.
- Sound generators should be used only as advised by your doctor, audiologist, or hearing care professional.
- Sound generators are not toys and should be kept out of reach of anyone who might cause themselves injury (especially children and pets).



### **CAUTION:**

- Should the user develop any side effects from using the sound generator, such as dizziness, nausea, headaches, a perceived decrease in auditory function or an increase in tinnitus perception, the user should discontinue use of the sound generator and seek medical evaluation.

- Discontinue use of the sound generator and consult promptly with a licensed physician if you experience any of the following conditions:
  1. Visible congenital or traumatic deformity of the ear.
  2. History of active drainage from the ear within the previous 90 days.
  3. History of sudden or rapidly progressive hearing loss within the previous 90 days.
  4. Acute or chronic dizziness.
  5. Unilateral hearing loss of sudden or recent onset within the previous 90 days.
  6. Audiometric air-bone gap equal to or greater than 15 dB at 500 Hertz (Hz), 1000 Hz, and 2000 Hz.
  7. Visible evidence of significant cerumen accumulation or a foreign body in the ear canal.
  8. Pain or discomfort in the ear.
- Discontinue use of the sound generator and consult promptly with your hearing care professional, if you experience changes in the tinnitus perception, discomfort, or interrupted speech perception, while using the tinnitus sound generator.
- The volume control is a feature in the TSG module used for adjusting the sound generator output level. To prevent unintended usage by pediatric, or physically or mentally disabled users, the volume control must, if enabled, be configured to only provide a decrease of the sound generator output level.
- Children, and physically or mentally disabled users will require guardian supervision while wearing the TSG hearing aid.
- Adjustment of the tinnitus sound generator settings, using a smartphone app, should only be performed by the parent or legal guardian in cases where the user is a minor.

- Use of the ReSound Assist for remote settings of the tinnitus sound generator should only be performed by the parent or legal guardian in cases where the user is a minor.



## Tinnitus Sound Generator warning to hearing care professionals

A hearing care professional should advise a prospective sound generator user to consult promptly with a licensed physician (preferably an ear specialist) before getting a sound generator, if the hearing care professional determines through inquiry, actual observation, or review of any other available information concerning the prospective user that the prospective user has any of the following conditions:

1. Visible congenital or traumatic deformity of the ear.
2. History of active drainage from the ear within the previous 90 days.
3. History of sudden or rapidly progressive hearing loss within the previous 90 days.
4. Acute or chronic dizziness.
5. Unilateral hearing loss of sudden or recent onset within the previous 90 days.
6. Audiometric air-bone gap equal to or greater than 15 dB at 500 Hertz (Hz), 1000 Hz, and 2000 Hz.
7. Visible evidence of significant cerumen accumulation or a foreign body in the ear canal.
8. Pain or discomfort in the ear.



**CAUTION:** The maximum output of the sound generator falls into the range that can cause hearing loss according to OSHA regulations. In compliance with NIOSH recommendations, the user should not use the sound generator for more than eight (8) hours a day when it is set to a level of 85 dB SPL or above. When the sound generator is set to levels of 90 dB SPL or above, the user should not use it for more than two (2) hours per day. In no case should the sound generator be worn at uncomfortable levels.

# General warnings and cautions



## WARNING:

- Consult a hearing care professional:
  - If you think there may be a foreign object in your ear canal
  - If you experience skin irritation
  - If excessive ear wax accumulates with the use of the hearing aid
- See also "Contraindications", page 8
- Never leave children or people with cognitive, intellectual, or mental health challenges unsupervised while using their hearing aids. Hearing aids contain small pieces that can be dangerous if swallowed.
- If any part of a hearing aid is swallowed, seek immediate medical attention.
- Do not wear your hearing aids while being exposed to radiation. Some types of radiation, such as from MRI or CT scanners, can affect the settings in your hearing aids, causing malfunction and potentially damage to your hearing.
- Other types of radiation, such as burglar alarms, room surveillance systems, mobile phones, metal detectors, and radio equipment will not damage your hearing aids. However, they may briefly affect the sound quality in your hearing aids and may create undesired sounds.
- Never use your hearing aids in places with explosive gases such as mines, oil fields, or similar locations unless these areas are certified for hearing aid use. Using your hearing aids in places that are not certified for hearing aid use can be dangerous.

- Do not attempt to dry your hearing aids in an oven, microwave oven, or other heating equipment. This will cause them to melt and may cause burns to your skin.
- External devices connected to the electrical input must be safe according to the requirements of IEC 60601-1, IEC 60065, EN/IEC 62368-1, or IEC 60950-1, as appropriate (wired connection, for example HI-PRO, SpeedLink).
- No modification of this device is allowed.

### **Warnings related to power hearing aids**

- A power hearing aid can produce very loud sound to compensate for a severe or profound hearing loss. Therefore, there is risk of further impairing the remaining hearing.
- Your hearing aids have been customized to amplify soft and loud sounds according to your particular needs. If the amplification seems too loud or you suspect the hearing aid is malfunctioning (e.g., you hear distorted or unusual sound), contact your hearing care professional. A malfunctioning hearing aid can damage your hearing.
- In general, exposure to loud sounds can damage your hearing. This could be loud music or loud environments. You can best protect your hearing by reducing exposure to loud sound and environments or by using hearing protection.



### **CAUTION:**

- Use your hearing aids as your hearing care professional recommends. Incorrect use may damage your hearing.
- Do not use a broken or modified hearing aid. It may not work properly and may be harmful to your hearing. It may also cause scratches or sores due to sharp edges.
- Use only original consumables from the manufacturer (e.g., wax guards).



- Use only accessories intended for use with your hearing aids. Consult your hearing aid professional for more information.
- Do not try to modify the shape of your hearing aid or accessories. This can cause skin reactions or sharp edges leading to scratches or sores.
- If you have two hearing aids, they may each be programmed differently. Do not swap them as this could damage your hearing. Your hearing aids are color-coded. Left = blue. Right = red. If your hearing aids are not color coded, ask your hearing care professional to add color coding.
- If you suspect that you have a dome, wax filter, or other object in your ear canal, consult your hearing care professional. These objects can be harmful and can cause an infection in your ear.
- If you have a sore or injury where your hearing aid touches your ear or head, continued use of the hearing aid may cause it to worsen or prevent it from healing. Consult your hearing care professional for assistance.
- Your hearing aids are tuned to your hearing. Do not allow others to use your hearing aids as this can damage their hearing.
- When using wireless functions, your hearing aid uses low-powered digitally coded transmissions to communicate with other wireless devices. It is possible, but not likely, that other electronic devices will be affected. If this happens, move the hearing aid away from the affected electronic device.
- Turn off hearing aid wireless functionality when this is required.

#### **For hearing care professionals**



**CAUTION:** Do not change the outer casing or any parts of a hearing aid unless appropriately protected against ESD.

# Cyber security warnings

Failing to follow these precautions can compromise the information security of your hearing aid and potentially cause hearing loss or tinnitus.



## **CAUTION:**

- Only connect your hearing aid to a trusted computer or mobile device, or one used by your hearing care professional.
- For 3 minutes after being turned on, your hearing aid is open to connections. Do not restart your hearing aid if requested by someone you don't trust as this may compromise the safety of your device.
- If your device plays the pairing sound at an unexpected time, this could indicate someone has gained access to your device.
- Only connect your hearing aid to the official ReSound mobile device app.
- Only apply remote fine tuning updates that you are expecting.
- Always use the newest software update available for your hearing aid.
- Only accept live assistance calls from the hearing care professional that you are expecting.

# Troubleshooting

Issue	Potential cause	Potential solution
Feedback or "whistling"	Is your earmold or dome inserted correctly in your ear?	Put it back in.
	Is the volume very loud?	Reduce the volume.
	Is the receiver wire broken or the earmold clogged?	Visit your hearing care professional.
	Are you holding an object (e.g., a hat or a telephone mouthpiece) close to the hearing aid?	Move your hand away to create more space between the hearing aid and the object.
	Is your ear full of wax?	Visit your doctor.
No sound	Is the hearing aid turned on?	Turn it on.
	Is there a battery in the hearing aid?	Insert a new battery.
	Is the battery still good?	Replace with a new battery.
	Is the receiver wire broken or the earmold clogged?	Visit your hearing care professional.
	Is your ear full of wax?	Visit your doctor.

<b>Issue</b>	<b>Potential cause</b>	<b>Potential solution</b>
Sound is distorted, spluttering, or weak?	Is the battery dead?	Replace with a new battery.
	Is the battery dirty?	Clean it or replace it with a new one.
	Is the receiver wire broken or the earmold clogged?	Consult your hearing care professional.
	Is there moisture in your hearing aid?	Use a desiccant (drying kit).
Battery drains very quickly.	Did you leave your hearing aid on for long periods of time?	Always turn off your hearing aid when you are not using it (e.g., at night).  Your batteries will run out faster when you use wireless functions like streaming from your smart device or from your TV with our TV streamer.
	Is the battery old?	Check the battery packaging.

# Regulatory information

## Warranties and repairs

The manufacturer provides a warranty on hearing aids in the event of defects in workmanship or materials, as described in applicable warranty documentation. In its service policy, the manufacturer pledges to secure functionality at least equivalent to the original hearing aid. As a signatory to the United Nations Global Compact initiative, the manufacturer is committed to doing this in line with environment-friendly best practices. Hearing aids therefore, at the manufacturer's discretion, may be replaced by new products or products manufactured from new or serviceable used parts, or repaired using new or refurbished replacement parts. The warranty period of hearing aids is designated on your warranty card, which is provided by your hearing care professional.

For hearing aids that require service, please contact your hearing care professional for assistance.

Hearing aids that malfunction must be repaired by a qualified technician. Do not attempt to open the case of hearing aids, as this will invalidate the warranty.

## Ambient conditions

### Temperature test, operation, transport, and storage information

Our hearing aids are subjected to various tests in temperature and damp heating cycling between -25 °C (-13 °F) and +70 °C (+158 °F) according to internal and industry standards.

### **During use**

During normal operation the temperature should not exceed the limit values of +5 °C (+41 °F) to +40 °C (104 °F) at a relative humidity range of 15% to 90%, non-condensing, but not requiring a water vapor partial pressure greater than 50 hPa. An atmospheric pressure between 700 hPa and 1060 hPa is appropriate.



**CAUTION:** During use, your hearing aids may reach temperatures up to 43 °C (109 °F).

### **During transport or storage**

During transport or storage, the temperature should not exceed the limit values of:

- -25 °C (-13°F) to +5 °C (41°F)
- +5 °C (41 °F) to +35 °C (95 °F) at a relative humidity up to 90 %, non-condensing
- >+35 °C (95 °F) to +70 °C (158 °F) at a water vapor pressure up to 50 hPa.

Warm-up time: 5 minutes.

Cool-down time: 5 minutes.

## Expected service lifetime

The expected service lifetime for the product when used as intended is:

Product	Lifetime
Hearing aid	5 years
Dome	3 months
Receivers	2 years
Electronic accessories (e.g., wireless accessories)	5 years

## Non-clinical testing (US only)

The devices covered within this user guide have undergone tests for the relevant non-clinical performance testing and biological endpoints in accordance with standards identified below:

- Electrical safety testing is performed according to IEC 60601-1:2005 + A1:2012+A2:2020, IEC 60601-2-66:2019, IEC 60601-1-11 Edition 2.0 2015-1, IEC 62133-2 Edition 1.0 2017- 02 and IEC 62368-1:2018/COR1:2020.
- Electromagnetic compatibility (EMC) testing is performed according to IEC 62479:2010, ANSI IEEE C63.19-2019 and IEC 60601-1-2:2014+A1:2020.
- Radio and Telecommunication testing is performed to be in compliance with applicable parts of the FCC rules in title 47 of the CFR.
- Electroacoustic testing is performed according to ANSI/ASA S3.22-2014 and ANSI/CTA 2051:2017
- Usability Engineering was performed in compliance with IEC 62366-1:2015

The devices covered in this user guide passed all tests for the relevant non-clinical performance testing and biological endpoints, namely cytotoxicity (ISO 10993-05:2009), sensitization, and intracutaneous reactivity (ISO 10993-10:2010).

Similarly, usability testing and software verification and validation demonstrated mitigation of risks to an acceptable level as well as reasonable assurance of safe and effective device performance.

## **Clinical data (US only)**

Devices have been evaluated clinically through equivalence to equivalent devices and similar devices on the market with similar intended purpose, e.g., to compensate for hearing impairment by amplifying and transmitting sound to the ear.

Based on technical and clinical data presented for the device in question, the equivalent predecessor, and generally similar devices, it is concluded to support the clinical performance expressed in user needs and claims.

The clinical data leaves no questions open regarding clinical performance and is for this reason deemed sufficient.



## Statement

This device complies with part 15 of the FCC rules and ISED rules. Its operation is subject to the following two conditions:

1. This device may not cause harmful interference.
2. This device must accept any interference received, including interference that may cause undesired operation.



**NOTE:** This equipment has been tested and found to comply with the limits for a Class B digital device, pursuant to part 15 of the FCC rules and ISED rules. These limits are designed to provide reasonable protection against harmful interference in a residential installation. This equipment generates, uses, and can radiate radio frequency energy and, if not installed and used according to the instructions, may cause harmful interference to radio communications.

However, there is no guarantee that interference will not occur in a particular installation. If this equipment does cause harmful interference to radio or television reception, which can be determined by turning the equipment off and on, the user is encouraged to try to correct the interference by one or more of the following measures:

- Redirect or relocate the receiving antenna.
- Increase the separation between the equipment and the receiver
- Connect the equipment to an outlet or a circuit that is different from the one to which the receiver is connected
- Consult the dealer or an experienced radio/TV technician for help.

Changes or modifications can void the user's authority to operate the equipment.

## The products are in compliance with the following regulatory requirements:

- In the EU: The device conforms to the General Safety and Performance Requirements according to Annex I of the EU Medical Device Regulation 2017/745 (MDR).
- GN ReSound A/S hereby declares that the radio equipment types CAR12A and CAR13A are in compliance with Directive 2014/53/EU.
- The full text of the EU declaration of conformity is available at the following internet address: [www.declarations.resound.com](http://www.declarations.resound.com).
- In the US: FCC CFR 47 Part 15, subpart C.
- In Canada: these hearing aids are certified under the rules of ISED.
- Japanese Radio Law and Japanese Telecommunications Business Law Compliance: This device has been certified pursuant to the Japanese Radio Law (電波法) and the Japanese Telecommunications Business Law (電気通信事業法). This device should not be modified (otherwise the granted designation number will become invalid).
- For other international regulatory requirements, please refer to the regulatory requirements of the specific country.

## Type designations

Hearing aid type designations for models included in this user guide are:

**CAR12A**, FCC ID: X26CAR12A, IC: 6941C-CAR12A

**CAR13A**, FCC ID: X26CAR13A, IC: 6941C-CAR13A.

## Hearing aid variants

**Mini Receiver In-the-Ear (RIE)** hearing aids of type **CAR12A** with FCC ID X26CAR12A, IC number 6941C-CAR12A, and size 312 Zinc-air battery are available in the following variants:

RU961-DRW, RU761-DRW, RU561-DRW

Nominal RF output power transmitted is -10.34 dBm.

**Receiver-in-the-ear (RIE)** hearing aids of type **CAR13A** with FCC ID X26CAR13A, IC number 6941C-CAR13A, and size 13 Zinc-air battery are available in the following variants:

RU962-DRW, RU762-DRW, RU562-DRW

Nominal RF output power transmitted is -7.1 dBm.

This device transmits and receives RF signals in the frequency range of 2.4 GHz - 2.48 GHz.

All of the above-mentioned hearing aids contain a magnetic induction radio operating at the 10.66 MHz frequency. The magnetic field strength of the radio is: Max. -24 dB $\mu$ A/m at a 10 m distance.

# Technical specifications

## RIE — LP/MP receiver

**Models:** RU961-DRW, RU761-DRW, RU561-DRW RU962-DRW, RU762-DRW, RU562-DRW

		LP	MP	
Reference test gain (60 dB SPL input) (The 2 lower curves in the Full-On and Ref.Test.Gain chart)	HFA	32	37	dB
Full-on gain (50 dB SPL input) (The 2 upper curves in the Full-On and Ref.Test.Gain chart)	Max	53	58	dB
	HFA	46	52	
Maximum output (90 dB SPL input)	Max.	113	116	dB SPL
	HFA	108	114	
Total harmonic distortion	500 Hz	0.5	0.6	%
	800 Hz	0.2	0.6	
	1600 Hz	0.4	0.7	
Telecoil sensitivity (1 mA/m input)* HFA - SPLIV @ 31.6 mA/m (ANSI) Full-on telecoil sensitivity @ 1 mA/m	Max	83	90	dB SPL
	HFA	92	97	
	HFA	76	83	
Equivalent input noise, w/o noise reduction		20	20	dB SPL
1/3 Octave Equivalent input noise, w/o noise reduction	1600 Hz	7	7	
Frequency range IEC 60118-0: 2015		100-9410	100-9160	Hz
Current Drain (Quiescent/Operating) (DRW models only)		0.81/1.04	0.81/1.04	mA

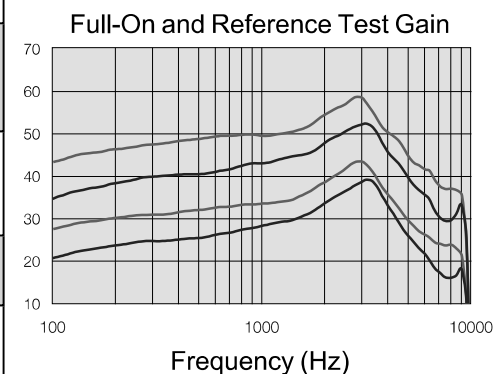
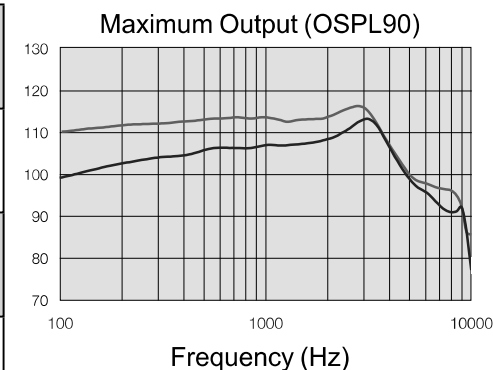

Measured according to ANSI S3.22-2014, IEC 60118-0:2015, JIS C 5512: 2015, 2cc coupler.

\* Telecoil is only for these models: RU962-DRW, RU762-DRW, RU562-DRW.

# RIE — LP/MP receiver (US only)

## Additional technical data

Latency, mid frequency delay (2 kHz)	5.1	ms
Attack/release time (2 kHz syllabic)	12 / 70	ms

## Input/Output response, measured in a 2cc coupler at the reference test gain @ 2 KHz

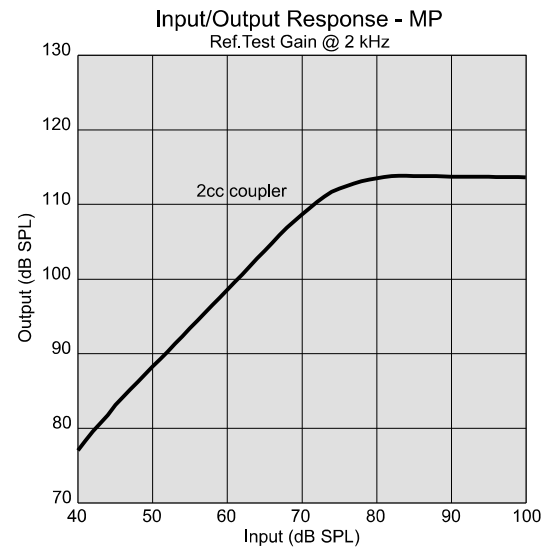
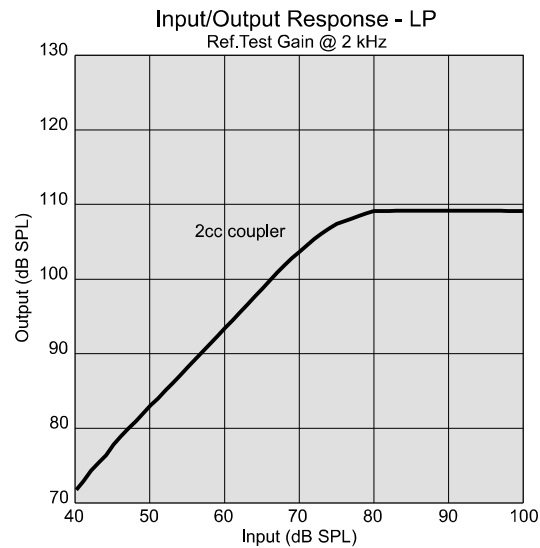

# RIE — HP/UP receiver

Models: RU961-DRW, RU761-DRW, RU561-DRW RU962-DRW, RU762-DRW, RU562-DRW

		HP	UP	
Reference test gain (60 dB SPL input) (The 2 lower curves in the Full-On and Ref.Test.Gain chart)	HFA	40	47	dB
Full-on gain (50 dB SPL input) (The 2 upper curves in the Full-On and Ref.Test.Gain chart)	Max. HFA	65 59	75 65	dB
Maximum output (90 dB SPL input)	Max. HFA	122 117	130 124	dB SPL
Total harmonic distortion	500 Hz	0.3	1.0	%
	800 Hz	0.7	1.3	
	1600 Hz	0.7	0.1	
Telecoil sensitivity (1 mA/m input)*	Max.	95	106	dB SPL
HFA - SPLIV @ 31.6 mA/m (ANSI)	HFA	100	108	
Full-on telecoil sensitivity @ 1 mA/m	HFA	88	95	
Equivalent input noise, w/o noise reduction		20	22	dB SPL
1/3 Octave Equivalent input noise, w/o noise reduction	1600 Hz	7	9	
Frequency range IEC 60118-0: 2015		100-7140	100-5010	Hz
Current Drain (Quiescent/Operating) (DRW models only)		0.81/1.04	0.81/1.04	mA

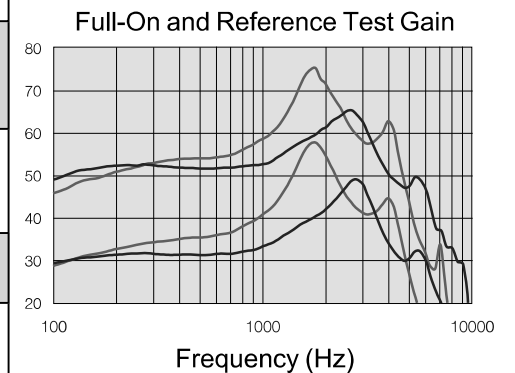
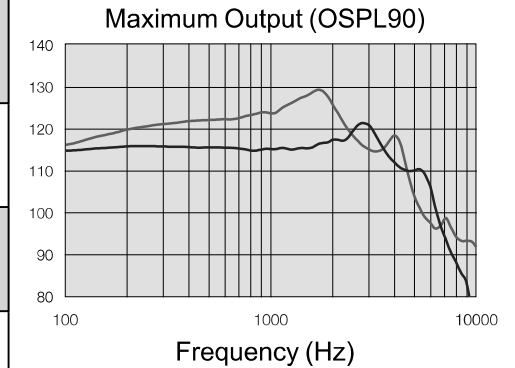

Measured according to ANSI S3.22-2014, IEC 60118-0:2015, JIS C 5512: 2015, 2cc coupler.

\* Telecoil is only for these models: RU962-DRW, RU762-DRW, RU562-DRW.

# RIE — HP/UP receiver (US only)

## Additional technical data

Latency, mid frequency delay (2 kHz)	5.1	ms
Attack/release time (2 kHz syllabic)	12 / 70	ms

## Input/Output response, measured in a 2cc coupler at the reference test gain @ 2 KHz

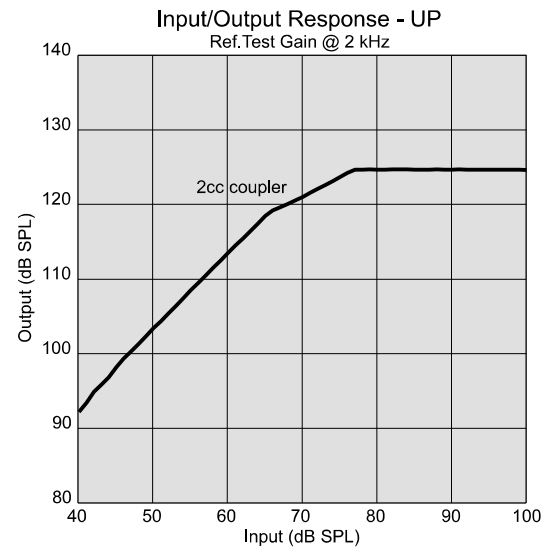
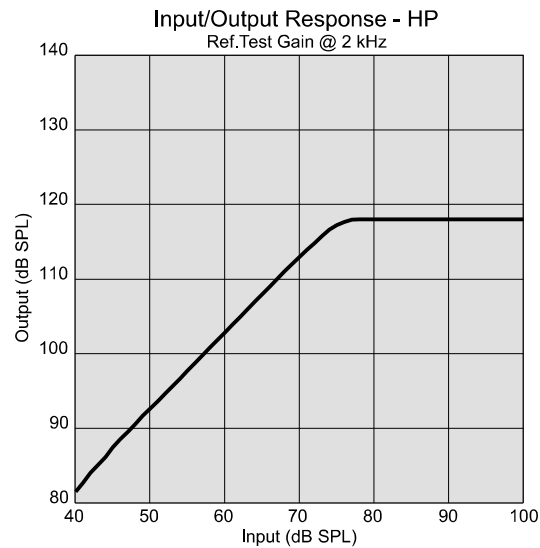

# RIE — MM receiver

Models: RU961-DRW, RU761-DRW, RU561-DRW RU962-DRW, RU762-DRW, RU562-DRW

		MM	
Reference test gain (60 dB SPL input) (The lower curve in the Full-On and Ref.Test.Gain chart)	HFA	33	dB
Full-on gain (50 dB SPL input) (The upper curve in the Full-On and Ref.Test.Gain chart)	Max.	53	dB
	HFA	47	
Maximum output (90 dB SPL input)	Max.	115	dB SPL
	HFA	110	
Total harmonic distortion	500 Hz	0.1	%
	800 Hz	0.9	
	1600 Hz	0.4	
Telecoil sensitivity (1 mA/m input)* HFA - SPLIV @ 31.6 mA/m (ANSI) Full-on telecoil sensitivity @ 1 mA/m	Max.	82	dB SPL
	HFA	93	
	HFA	75	
Equivalent input noise, w/o noise reduction		20	dB SPL
1/3 Octave Equivalent input noise, w/o noise reduction	1600 Hz	7	
Frequency range IEC 60118-0: 2015		100-9100	Hz
Current Drain (Quiescent/Operating) (DRW models only)		0.82/1.04	mA

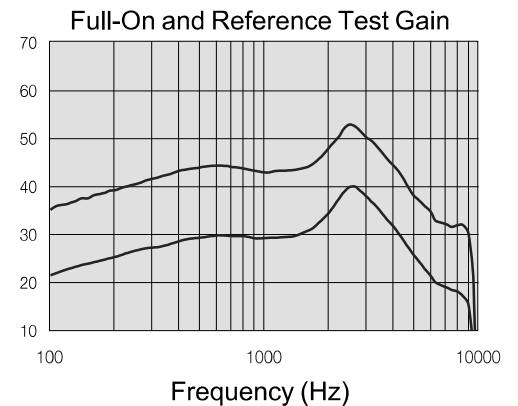
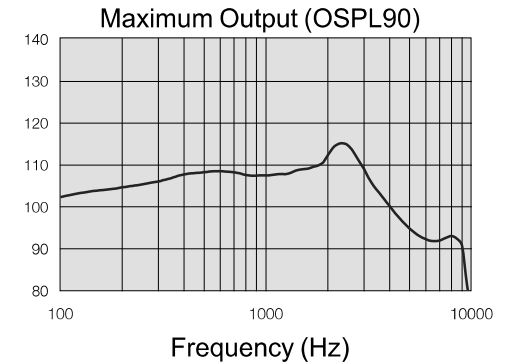

Measured according to ANSI S3.22-2014, IEC 60118-0:2015, JIS C 5512: 2015, 2cc coupler.

\* Telecoil is only for these models: RU962-DRW, RU762-DRW, RU562-DRW.



## RIE — MM receiver (US only)

### Additional technical data

Latency, mid frequency delay (2 kHz)	5.1	ms
Attack/release time (2 kHz syllabic)	12 / 70	ms

### Input/Output response, measured in a 2cc coupler at the reference test gain @ 2 KHz

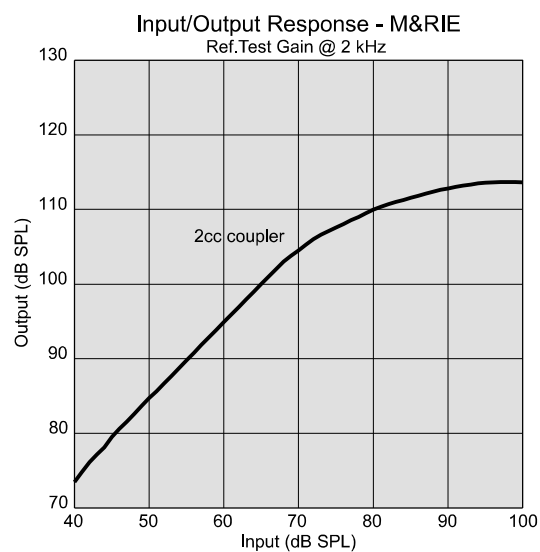

# Additional information

## Acknowledgements

Portions of this software are written by Kenneth MacKay (micro-ecc) and licensed under the following terms and conditions:

Copyright © 2014, Kenneth MacKay. All rights reserved.

Redistribution and use in source and binary forms, with or without modification, are permitted provided that the following conditions are met:

- Redistributions of source code must retain the above copyright notice, this list of conditions and the following disclaimer.
- Redistributions in binary form must reproduce the above copyright notice, this list of conditions and the following disclaimer in the documentation and/or other materials provided with the distribution.

THIS SOFTWARE IS PROVIDED BY THE COPYRIGHT HOLDERS AND CONTRIBUTORS “AS IS” AND ANY EXPRESS OR IMPLIED WARRANTIES, INCLUDING, BUT NOT LIMITED TO, THE IMPLIED WARRANTIES OF MERCHANTABILITY AND FITNESS FOR A PARTICULAR PURPOSE ARE DISCLAIMED. IN NO EVENT SHALL THE COPYRIGHT HOLDER OR CONTRIBUTORS BE LIABLE FOR ANY DIRECT, INDIRECT, INCIDENTAL, SPECIAL, EXEMPLARY, OR CONSEQUENTIAL DAMAGES (INCLUDING, BUT NOT LIMITED TO, PROCUREMENT OF SUBSTITUTE GOODS OR SERVICES; LOSS OF USE, DATA, OR PROFITS; OR BUSINESS INTERRUPTION). HOWEVER CAUSED AND ON ANY THEORY OF LIABILITY, WHETHER IN CONTRACT, STRICT LIABILITY, OR TORT (INCLUDING NEGLIGENCE OR OTHERWISE) ARISING IN ANY

WAY OUT OF THE USE OF THIS SOFTWARE, EVEN IF ADVISED OF THE POSSIBILITY OF SUCH DAMAGE.



**NOTE:** Use of the Made for Apple badge means that an accessory has been designed to connect specifically to iPhone, iPad, and iPod touch models, and has been certified by the developer to meet Apple performance standards. Apple is not responsible for the operation of this device or its compliance with safety and regulatory standards.

© 2023 GN Hearing A/S. All rights reserved. ReSound is a trademark of GN Hearing A/S. Apple, the Apple logo, iPhone, iPad, iPod touch are trademarks of Apple Inc., registered in the U.S. and other countries. App Store is a service mark of Apple Inc., registered in the US and other countries. Android, Google Play and the Google Play logo are trademarks of Google LLC. The Bluetooth word mark and logos are registered trademarks owned by Bluetooth SIG, Inc.

Manufacturer according to EU Medical  
Device Regulation 2017/745:

Manufacturer according to FDA:

Manufacturer according to Health Canada:



GN ReSound A/S  
Lautrupbjerg 7  
DK-2750 Ballerup  
Denmark

**GN ReSound North America**  
8001 E Bloomington Freeway  
Bloomington, MN 55420  
USA  
1-888-735-4327  
resound.com

**ReSound Canada**  
2 East Beaver Creek Road, Building 3  
Richmond Hill, ON L4B 2N3  
Canada  
1-888-737-6863  
resound.com

**ReSound Government Services**  
8001 E Bloomington Freeway  
Bloomington, MN 55420  
USA  
1-800-392-9932  
resound.com/veterans



Any serious incident that has occurred in relation to the device should be reported to the Legal manufacturer GN ReSound A/S and the competent authority of the EU Member State in which the user and/or patient is established.